

ZANUSSI



**ELECTRIC
DOUBLE OVEN
AND GRILL
ZCE 8021**

INSTRUCTION BOOKLET

TECHNICAL DETAILS

MODEL NO. ZCE8021

Voltage: 230-240 Volts AC 50Hz

Wattage: 10.3-11.2 kW

Height: 900mm

Width: 600mm

Depth: 600mm

Weight 60kg

 This appliance complies with: European Council Directive 73/23/EEC.
EMC Directive 89/336/EEC.
CE Marking Directive 93/68/EEC.

CONTENTS

Technical Details	2
Contents	3
Preface	5
Safety	6
Before Installation	6
During Operation	6
After Use	7
General	7
Introduction	8
Rating Plate	8
Installation	8
General Notes on Using Your Appliance	9
About Condensation and Steam	9
Control Panel Indicator Neon(s)	9
Grill and Oven Furniture	9
Getting To Know Your Appliance	10
The Control Panel	10
The Electronic Timer	11
The Ceramic Hob	15
Using the Hob	15
Recommended Saucepans	15
Hints and Tips	15
Deep Fat Frying	16
Preserving	16
The Dual Grill	17
Selecting the Grill	17
Things to Note	17
The Grill Pan and Handle	17
Hints and Tips	18
Grilling Chart	18
The Top Oven	19
Uses of the Top Oven	19
Selecting the Top Oven.....	19
Things to Note	19
To Fit the Top Oven Shelf	19
Hints and Tips	20
The Main Fan Oven	21
Uses of the Main Fan Oven	21
Selecting the Main Fan Oven.....	21
Things to Note	21
To Fit the Main Oven Shelves	21
Hints and Tips	22
Oven Cooking Chart	23
Roasting Chart	24

CONTENTS

Defrost Feature	25
Uses of Defrost Feature	25
Selecting Defrost	25
Things to Note	25
Hints and Tips	25
Care and Cleaning	26
Cleaning Materials	26
Cleaning the Ceramic Hob	26
Hints and Tips	27
Cleaning the Outside of the Appliance	27
Cleaning the Control Knobs and Handles	27
Cleaning the Grill and Oven Furniture	27
Cleaning Inside the Oven and Grill Compartments	28
Care of Stayclean Surfaces	28
Hints and Tips	28
Cleaning the Door Glass	29
Replacing an Oven Light Bulb	29
Something Not Working?	30
Service and Spare Parts	31
Guarantee Conditions	32
Notes	33

PREFACE

Dear Customer,

Thank you for buying a Zanussi-Electrolux appliance. With our experience in developing and manufacturing the very best in U.K. appliances, you can be assured that you have purchased a hard working, reliable, quality product.

Zanussi-Electrolux appliances comply with British Standard safety and performance requirements. They are covered by a 12 month parts and labour guarantee.

To get the best from your new appliance, we ask that you PLEASE READ THESE INSTRUCTIONS CAREFULLY. Particular attention should be made to cooking times and temperatures, which may differ, from your previous appliance.

It is most important that this instruction book is retained with the appliance for future reference. Should the appliance be sold, or if you move house and leave the appliance, always ensure that the book remains with the appliance. This will enable the new owner to be acquainted with the functioning of the appliance and the relevant warnings.

Please read the whole instruction book before attempting to use the appliance ensuring you follow the recommendations given.

SAFETY

THESE WARNINGS ARE PROVIDED IN THE INTERESTS OF YOUR SAFETY. ENSURE THAT YOU UNDERSTAND THEM ALL BEFORE INSTALLING OR USING THE APPLIANCE.

PLEASE
READ
CAREFULLY

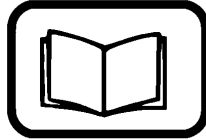

BEFORE INSTALLATION



This appliance is heavy and care **must** be taken when moving it.



Ensure that all packaging, both inside and outside the appliance, has been removed before the appliance is used.

If the appliance is to be placed on a base, measures must be taken to prevent the appliance from slipping.



Do not try to *lift* or move the appliance by pulling the door handles.

The electrical installation work **must** be undertaken by a qualified electrician/competent person.



It is dangerous to alter or modify the specifications of the appliance in any way.

Do not use the appliance if the ceramic glass is damaged. If a fault or crack becomes visible during cooking, disconnect the appliance immediately from the electricity supply and contact your local Service Force Centre.

Do not place silver foil or plastic containers on ceramic glass.

Do not allow young children to play with any part of the packaging.



After installation, please dispose of the packaging with due regard to safety and the environment, your local authority can arrange this.

DURING OPERATION

This appliance is not intended to be operated by means of an external timer or remote control system.



Do not use this appliance if it is in contact with water. **Never** operate it with wet hands.



This appliance is designed to be operated by adults. Young children **must not** be allowed to tamper with the appliance or play with the controls.

During use the appliance becomes **Hot**. Care should be taken to avoid touching the heating elements inside the oven.

CAUTION: Accessible parts may be hot when the grill is in use. Young children should be kept away.



Take **great care** when heating fats and oils, as they will ignite if they become too hot.

This appliance has been designed for cooking edible foodstuffs only, and **must not** be used for any other purposes.



Never place plastic or any other material which may melt in the oven or on the hob.



Ensure cooking utensils are large enough to contain foods to prevent spillages and boil overs.



The handles of saucepans which are smaller than the heated area on the hob will become hot. **Ensure** your hand is protected before handling the pan.



Take care to follow the recommendations given for tending the food when grilling.

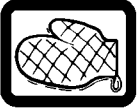

Always use oven gloves to remove and replace food in the oven.



Ensure that you support the grill pan when it is in the withdrawn or partially withdrawn position.

Ensure that all vents are left unobstructed to ensure ventilation of the oven cavity.

Ensure the anti-tilt shelves are put in place correctly.



Never line any part of the appliance with aluminium foil. **Do not** allow heatproof cooking material, e.g. roasting bags, to come into contact with oven elements.



Always stand back from the appliance when opening the oven door to allow any build up of steam or heat to release.



Never leave the appliance unattended when the doors are open.



Do not place sealed cans or aerosols inside the oven. They may explode if they are heated.

Do not leave the hotplates switched ON for long periods when not covered by a saucepan. The controls and cabinets may overheat.

AFTER USE



Ensure that all control knobs are in the OFF position when not in use.



For hygiene and safety reasons this appliance should be kept clean at all times. A build-up of fats or other foodstuffs could result in a fire, especially in the grill pan.



Do not leave utensils containing foodstuffs, e.g. fat or oil in or on the appliance in case it is inadvertently switched on.



Cookers and hobs become **very hot**, and retain their heat for a long period of time after use. Children should be kept well away from the appliance until it has cooled.

GENERAL



Under no circumstances should any repairs be carried out by an inexperienced person as this may cause injury or serious malfunction.

This appliance should be serviced by an authorised Service Engineer and only genuine approved spare parts should be used.



Do not stand on the appliance or on the open oven door.



Do not hang towels, dishcloths or clothes from the appliance or its handle. They are a safety hazard.

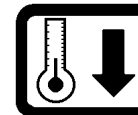

Always allow the cooling fan to cool the appliance down before switching off at the wall prior to carrying out any cleaning or maintenance work.



Only clean this appliance in accordance with the instructions given in this book. Extreme care must be taken when using a ceramic hob scraper.

Your safety is of paramount importance.

Therefore, if you are unsure about any of the meanings of these **WARNINGS** contact the:

Customer Care Department
Telephone 0870 5 727727

INTRODUCTION

WARNING: THIS APPLIANCE MUST BE EARTHED

RATING PLATE

This is situated on the front frame of the appliance and can be seen upon opening the door. Alternatively the rating plate may also be found on the back or top of some models (where applicable).

The appliance must be protected by a suitably rated fuse or circuit breaker. The rating of the appliance is given on the rating plate.

Do not remove the rating plate from the appliance as this may invalidate the guarantee.

INSTALLATION

If your appliance has been damaged in transit, contact your supplier immediately. **DO NOT** attempt to install it.

Your appliance left the factory fully packaged to protect it from damage. If it is delivered without packaging and damage has occurred, the manufacturer cannot accept responsibility. Contact your supplier for advice.

Once the packaging has been removed the appliance should only be moved by hand. **DO NOT** use a sack barrow or any other aid to lift the appliance as damage may occur.

Connection to the electricity supply must be carried out by a qualified electrician/competent person.

The electrical connection should be made using a double pole isolating switch (cooker socket) with at least 3mm contact separation in all poles. The cable must have conductors of sufficiently high cross-sectional area to prevent overheating and deterioration.

The recommended cross-section area is six square millimetres (6.00mm²).

The cable must be routed away from potentially hot areas marked by X in the diagram below.

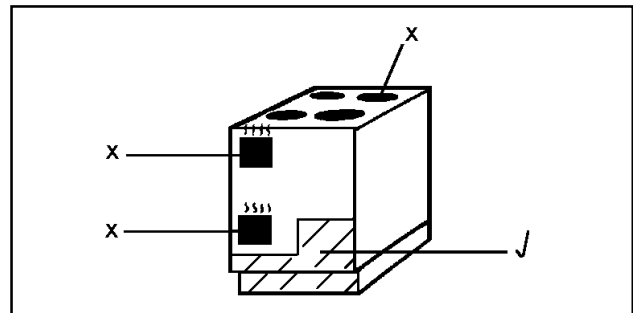

To move the appliance, open the main oven door, and lift the appliance by holding inside the top of the compartment.

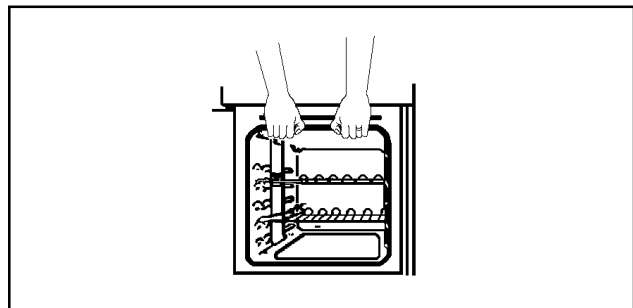

This is a type X appliance which means it is free-standing and can be fitted with cabinets on one or both sides. It may also be fitted in a corner setting.

Side walls which are above hob level should be protected by heat resistant non-combustible material and **MUST NOT** be nearer than 40mm to the hob side.

A nominal air gap of 2mm at either side of the appliance is required to enable the appliance to be moved into position. It is recommended that proprietary trims are fitted to protect the worktops of either side of the appliance. These are available from most DIY stores.

Always ensure an air gap is maintained at hotplate level. Tiles or other forms of deep wall covering should not obscure this gap.

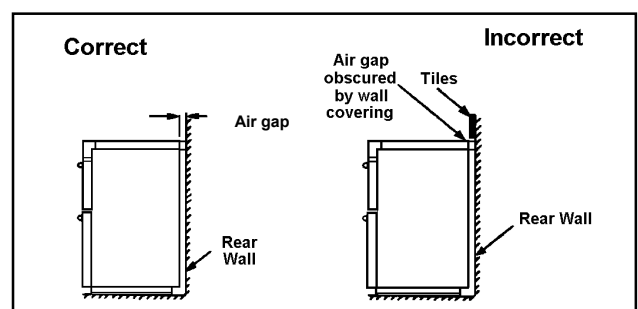

INTRODUCTION

Overhanging surfaces or a cooker hood should be a minimum of 685mm above the hob.

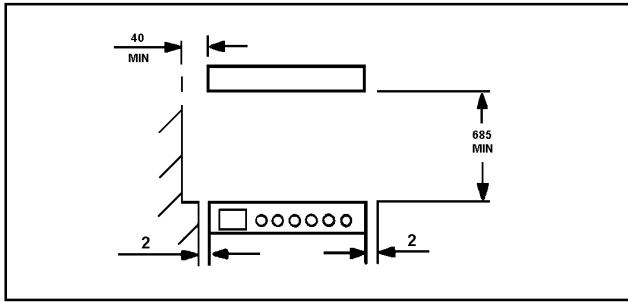

It is important to ensure that the appliance is level after installation. Levelling feet are fitted to the appliance to accommodate uneven floors.

GENERAL NOTES ON USING YOUR APPLIANCE

We suggest that you run the oven elements for 10 – 15 minutes at 220°C to burn off any residue from their surfaces.

The procedure should be repeated with the grill for approximately 5 – 10 minutes.

During this period an odour may be emitted, it is therefore advisable to open a window for ventilation.

ABOUT CONDENSATION AND STEAM

When food is heated it produces steam similar to a boiling kettle. The ovens are vented to allow some of the steam to escape. However, always stand back from the appliance when opening the oven door to allow any build up of steam or heat to release.

If the steam comes into contact with a cool surface on the outside of the appliance, e.g. a trim, it will condense and produce water droplets. This is quite normal and is not caused by a fault on the appliance.

To prevent discolouration, regularly wipe away condensation and also soilage from surfaces.

For your safety wallcoverings at the rear of the appliance should be securely fixed to the wall.

CONTROL PANEL INDICATOR NEON(S)

The indicator neon will operate when the grill (where applicable) or oven(s) is switched on. The indicator neon will glow. It may turn on and off during use to show that the setting is being maintained. If the neon does not operate as the instructions indicate the controls have been incorrectly set. Return all controls to zero and reset following the instructions for the required setting.

THE COOLING FAN FOR THE CONTROLS

The cooling fan will always come on when the grill and the top oven are switched on. If they are only used for a short period of time the fan will switch off when the controls are turned off. If the grill or top oven are used for a longer period of time the fan will run on depending on the temperature, and may turn on and off until the appliance has cooled.

In the case of the main oven, the cooling fan may not switch on except when used for a longer period of time. The cooling fan may run on, and turn on and off after the control knobs have been switched off, until the appliance has cooled. **Do not** switch the appliance off at its power point until the fan has cooled the appliance down.

GRILL AND OVEN FURNITURE

The following items of grill and oven furniture have been supplied with the appliance. If you require replacements of any of the items listed below please contact your local Service Force Centre, quoting the relevant part number.

1 grill pan
(311409401)

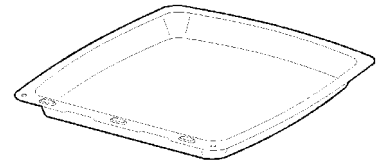

1 grill pan handle
(311468100)

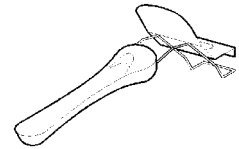

Note:

If you require an additional handle for your grill pan, this can be ordered from your local Service Force Centre by quoting part number 311479800/6.

1 grill pan grid
(311419801)

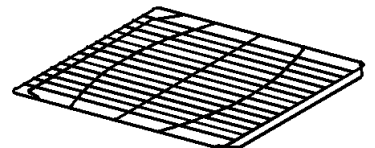

1 cranked shelf
for grilling and top
oven cooking only

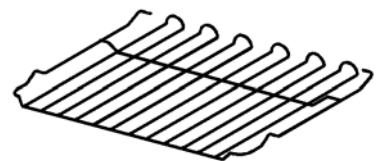

2 straight shelves
for fan oven cooking

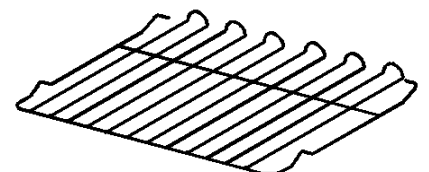

GETTING TO KNOW YOUR APPLIANCE

THE CONTROL PANEL

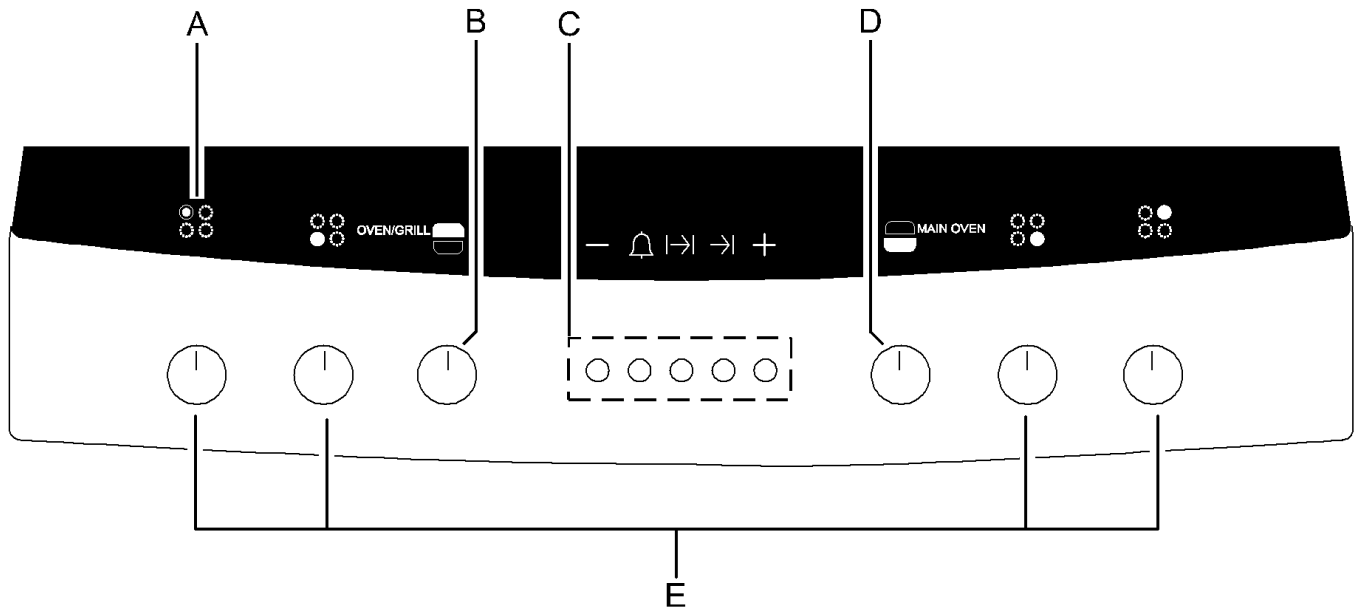

FEATURES

- A - Dual Hotplate Control
- B - Top Oven/Grill Temperature Control
- C - Electronic Timer
- D - Main Oven Temperature Control
- E - Hotplate Controls

ELECTRONIC TIMER

KEY

- A ANGLED TIMER DISPLAY
- B FUNCTION NEONS
- C VERTICAL TIMER CONTROLS
- D DECREASE CONTROL
- E COUNTDOWN
- F COOK TIME
- G END TIME
- H INCREASE CONTROL

NOTE:

The time of day must be set before the oven will operate manually.

1. HOW TO SET THE TIME OF DAY

The oven has a 24 hour clock.

When the electricity supply is first switched ON, the display will flash as Fig. 12.00.

To set the correct time press the increase control button (+) and if necessary, the decrease control button (-) until the correct time on the 24 hour clock is reached, e.g. 10.00am as Fig.1.

Note: The increase and decrease control buttons operate slowly at first, and then more rapidly. They should be pressed separately.

2. HOW TO SET THE COUNTDOWN

The 'Countdown' gives an audible reminder at the end of any period of cooking. This cooking period may be up to 19 hrs 59 mins. It is not part of the automatic control.

To set, press the 'Countdown' button (). The 'Countdown' indicator neon will illuminate and the display will read 0.00 as Fig. 2.

To set, press the correct time duration depress the increase control (+) until the display indicates the interval to be timed, e.g. 1 hr 45mins as Fig.3. If necessary depress the decrease control (-) to achieve the correct time interval.

NOTE: This must be completed within 5 seconds of first pressing the 'Countdown' button.

The display will return to the time of day and the 'Countdown' indicator will be illuminated.

During the operation of the 'Countdown', you can check the remaining time period by pressing the 'Countdown' button ().

The 'Countdown' will sound intermittently for up to 2 minutes at the end of the timed period. The sound can be stopped by pressing any button.

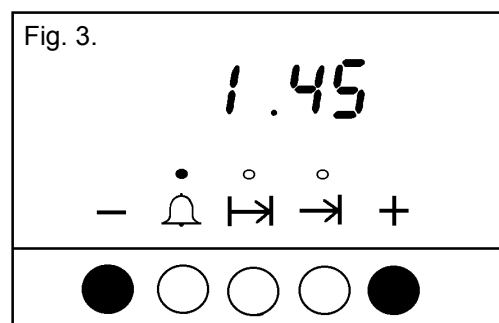
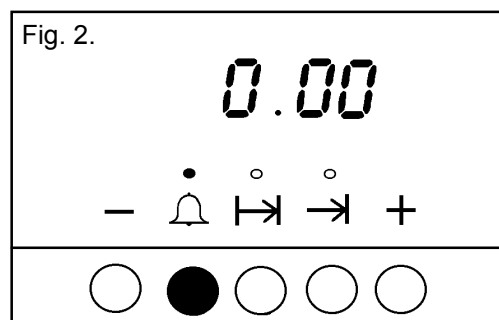
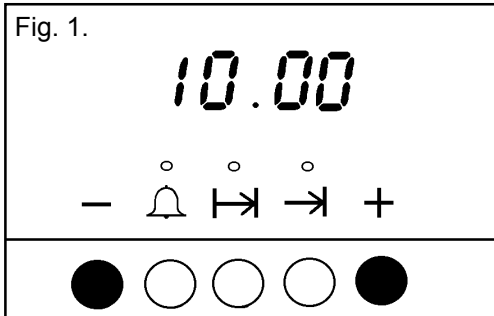
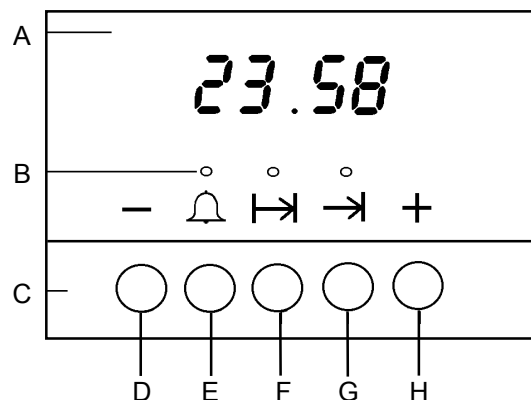

TO CANCEL THE COUNTDOWN

If you change your mind and want to cancel the 'Countdown', press the 'Countdown' button (🔔) and then the decrease control (-) until 0.00 shows in the display as Fig. 4. The 'Countdown' indicator neon will continue to flash for a few seconds and then return to the time of day.

3. SETTING THE OVEN TIMER CONTROL

The main oven only can be automatically timed.

When using the timer control for the very first time, it is advisable to let it operate while you are at home. The displays can be checked to show that it is operating correctly and you will feel confident to leave a meal to cook automatically in the future.

A) TO SET THE TIMER TO SWITCH ON AND OFF AUTOMATICALLY

- i) Ensure the electricity supply is switched ON and that the correct time of day is displayed, e.g. 9. a.m. as Fig. 5.
- ii) Place food in the oven.
- iii) To set the length of cooking time, press the 'Cook Time' button (⏸). Press the increase control (+) until the required length of cooking time is displayed, e.g. 2 hrs 15 mins. as Fig. 6. If necessary depress the decrease control (-) until the correct time interval is achieved.

Remember, this must be completed within 5 seconds of first pressing the 'Cook Time' button.

- iv) Release the buttons. The 'Cook Time' indicator neon (⏸) will be illuminated.
- v) To set the 'End Time'. Press the 'End Time' button (⏸). Press the increase control (+) until the required stop time is displayed, e.g. 12.15 p.m. as Fig. 7. If necessary depress the decrease control (-) until the correct time interval is achieved.
- vi) Release the buttons. The time of day will be displayed after 5 seconds. The 'Cook Time' (⏸) and 'End Time' (⏸) indicator neons will be illuminated.
- vii) Set the main oven control to the required temperature. The oven indicator neon should be OFF.

NOTE: When the automatic timed period starts, the oven indicator neon will glow. It may turn on and off during use to show that the setting is being maintained.

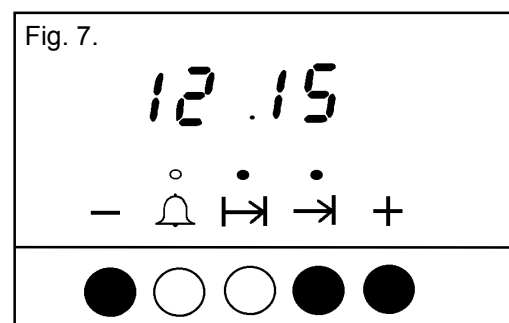
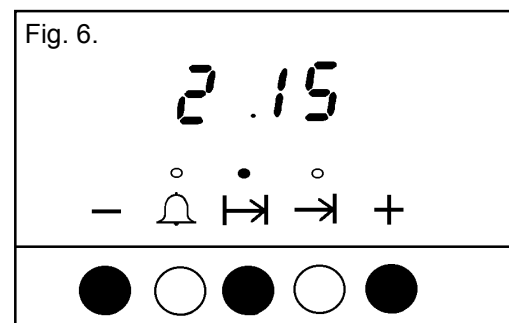
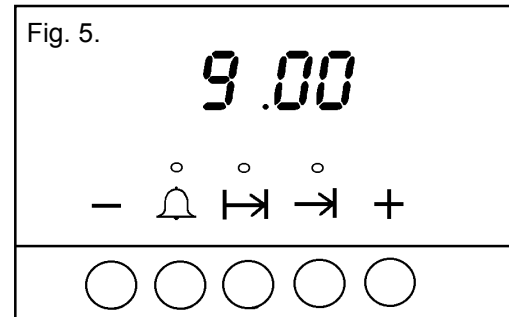
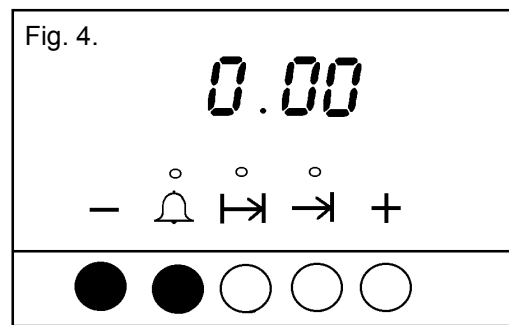

B) TO SET THE TIMER TO SWITCH OFF ONLY

- i) Ensure the electricity supply is switched ON and that the correct time of day is displayed, e.g. 10.00 a.m. as Fig. 8.
- ii) Place food in the oven.
- iii) To set the length of cooking time, press the 'Cook Time' button (|→|). Press the increase control (+) until the required length of cooking time is displayed, e.g. 2 hrs 15 mins. as Fig. 9. Depress the decrease control (-) if necessary, until the correct time interval is achieved.
- iv) Release the buttons. The 'Cook Time' indicator neon (|→|) will illuminate and the time of day will be displayed after 5 seconds.
- v) Set the oven temperature. The oven indicator neon should be ON.
- vi) To check the 'End Time' during the cooking period, simply press the 'Cook Time' button (|→|) and the remaining time will be displayed, as Fig. 10.

4. TO CANCEL AN AUTOMATIC PROGRAMME

- i) To cancel an automatic programme press the 'Cook Time' button until the 'Cook Time' indicator neon (|→|) flashes. Press the decrease control (-) until the display reads 0.00 as Fig. 11.
- ii) Release the buttons. The 'Cook Time' indicator neon (|→|) will flash and after 5 seconds return to the time of day.
- iii) Turn off the oven controls.

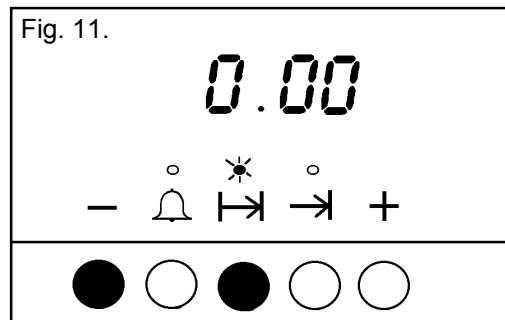
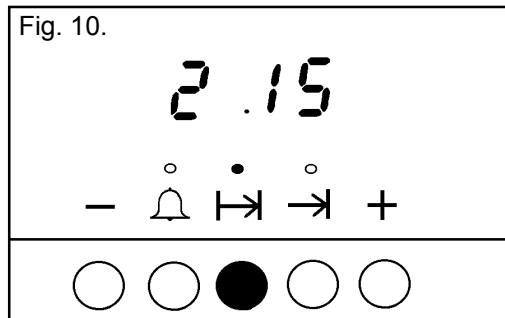
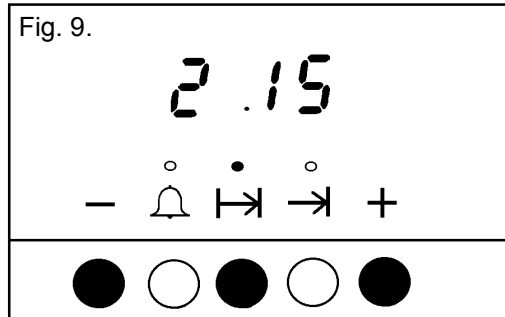
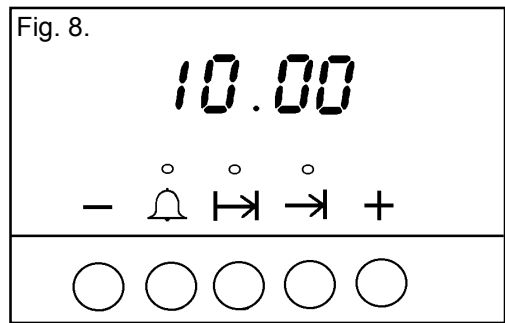

5. TO RETURN THE APPLIANCE TO MANUAL

At the end of a timed cooking period, the indicator neon will flash and an alarm will sound for up to 2 minutes.

- i) To stop the sound press any of the three buttons.
- ii) The 'Cook Time' neon (|→|) will flash.
- iii) To return the cooker to manual press the 'Cook Time' (|→|) button as Fig 12.
- iv) Turn off the oven controls.

6. THINGS TO NOTE

- In the event of an interruption of the electricity supply, the timer will reset itself to 12.00, and all programming will be cancelled.
- If you wish to alter the time of day. Press the 'Cook Time' (|→|) and the 'End Time' (→|) buttons at the same time and hold for 5 seconds, as Fig. 13. The display will flash. Press the increase control (+) until the required time is displayed. Depress the decrease control (-) if necessary. The display will flash and after 5 seconds return to the time of day.

7. AUTOMATIC COOKING

It is advisable to leave food in the oven for as short a time as possible before automatic cooking. Always ensure commercially prepared food is well within its use by date and that home prepared food is fresh and of good quality.

When cooking is complete, **do not** leave food to stand in the oven, but remove and cool it quickly if the food is not to be consumed immediately.

Always ensure food in the oven has been covered before cooking if it is not possible to remove food immediately after cooking.

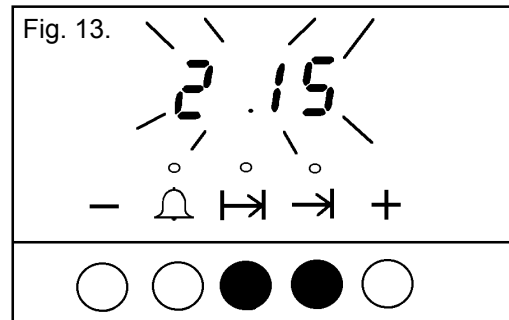
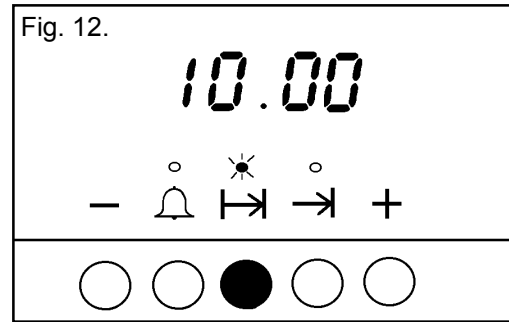

THE CERAMIC HOB

CAUTION: DO NOT USE THE APPLIANCE IF THE CERAMIC GLASS IS DAMAGED. IF A FAULT OR CRACK BECOMES VISIBLE DURING COOKING, DISCONNECT THE APPLIANCE IMMEDIATELY FROM THE ELECTRICITY SUPPLY AND CONTACT YOUR LOCAL SERVICE FORCE CENTRE.

USING THE HOB

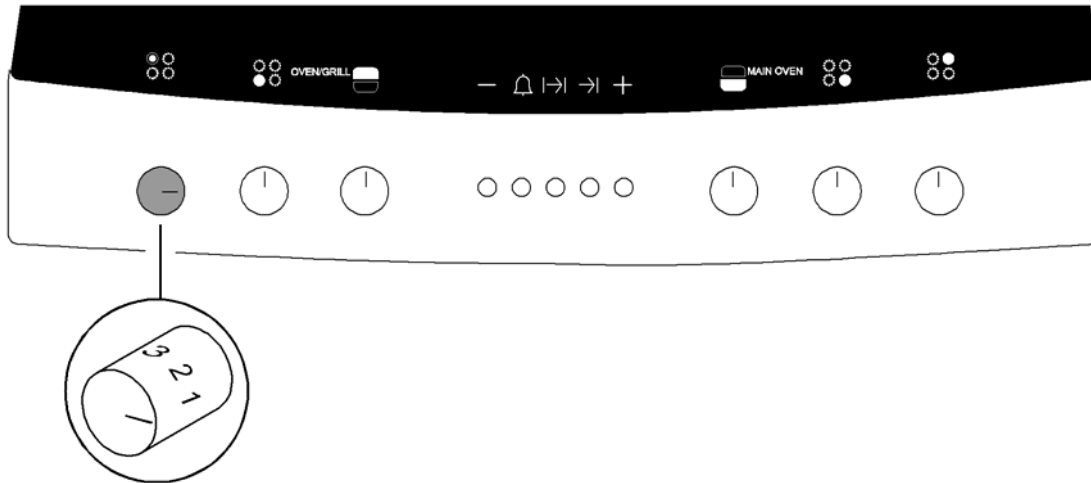

- To operate the dual hotplate turn the control knob clockwise for the full area, or anticlockwise for the centre section.
- The inner section is very economical when cooking with small diameter saucepans.
- For single hotplates, turn the control knob in either direction to vary the heat setting. The highest number represents the hottest setting and the lowest number represents the coolest setting. Choose a setting appropriate to the quantity and type of food to be cooked.

RECOMMENDED SAUCEPANS

For speed and economy only good quality saucepans with flat bases and close fitting lids are recommended. The saucepan base should be approximately the same size as the cooking area, a base diameter of up to 225mm (9") may be used on a 180mm (7") heated area.

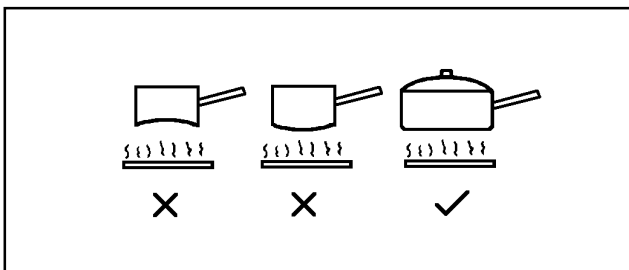

Pressure cookers, preserving pans, etc., should comply with the recommendations given above.

Ensure that new saucepans are well scrubbed to remove edges and take off any deposits left from manufacture.

Traditional round bottomed Woks **must not be** used even with a stand. Woks with flat-bottomed bases are available and do comply with the above recommendations.

NOTE

Occasionally the heated areas may be seen to switch ON and OFF when higher heat settings are being used. This is due to a safety device which prevents the glass from overheating. Some switching ON and OFF when cooking at high temperatures, e.g. deep fat frying is quite normal, causes no damage to the hob and little delay in cooking times.

Excessive switching may however be caused by the use of an unsuitable saucepan or a saucepan which is smaller than the heated area. If excessive switching occurs, discontinue use of the saucepan.

HINTS AND TIPS

- Lift, rather than slide saucepans on and off the heated areas. This will reduce the risk of scratches and metal marks from saucepans with aluminium bases. Metal marks can be easily cleaned off providing they are not allowed to burn on.

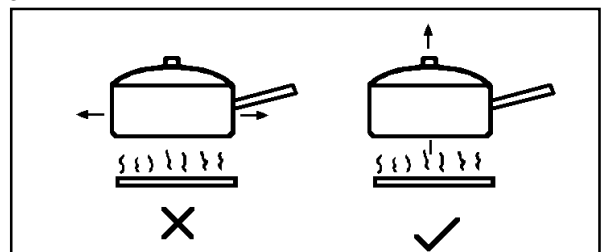

- Follow any guidelines provided by the saucepan manufacturer, particularly those relating to recommended heat settings.
- Avoid using thin, badly dented or distorted saucepans as they can lead to sticking and burning of food.

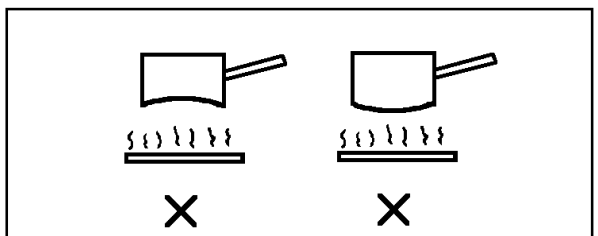

- To prolong the life of the hotplates:-
 - **DO NOT** place aluminium foil and plastic vessels on the hot surface of the ceramic hob and **DO NOT** use the surface for storage purposes.
 - Never use utensils with a skirt, e.g. a bucket.
 - Never use an asbestos mat.
 - Never leave the hotplates ON when not covered with a saucepan.
- Ensure that the hob and saucepans are clean and dry before the start of cooking to reduce cleaning.
- Follow the cleaning instructions very closely to keep the hob looking like new.
- **If spillage occurs with sugar solutions, e.g. jams and syrups, it must be wiped from the hob before it sets and becomes hard otherwise damage to the hob will occur.**

HOT HOB INDICATOR

The ceramic hob is fitted with a hot hob indicator light which illuminates when the hob is too hot to touch. The light will go OFF when the hob has cooled.

DEEP FAT FRYING

SPECIAL FRYING NOTE:

For safety purposes when deep fat frying, fill the pan one third full of oil, **DO NOT** cover the pan with a lid and **DO NOT** leave the pan unattended. In the unfortunate event of a fire, switch the appliance OFF at the electricity supply and cover the pan with a lid or damp cloth to assist in smothering the flames.

DO NOT use water on the fire. Leave the pan to cool for at least 30 minutes before moving it.

DO NOT leave the fat or oil in the frying pan on the hob to store it in case the hob is inadvertently switched ON.

1. Preparing the food.

Seal the food by coating with flour, egg and breadcrumbs or batter. **Do not** use a basket with batter coated foods as they will stick.

2. Amount of oil.

For safety purposes fill the pan only one-third full of oil.

3. Testing the temperature of the oil.

It is advisable to use a thermometer to test the temperature of the oil. Alternatively, drop a small cube of bread into the oil which should brown in just under a minute if the oil is at the correct temperature of 190°C/375°F.

4. Cooking the food.

Lower the food gently into the oil. **Do Not** add too much food at once or the temperature of the oil will be reduced and may result in soggy, greasy food.

Turn the food if necessary; doughnuts float to the surface so will not brown on the upperside if not turned. Once cooked, drain the food on absorbent paper.

5. Double frying chips.

Double frying will ensure good chips. First fry the chips for a few minutes at 170°C/340°F to seal the outside. Remove the chips from the oil. Increase the temperature of the oil to 190°C/375°F to finish cooking and brown the chips.

Chips may be kept for several hours after the first frying before finishing off with the second frying.

6. Frying temperatures

	Celsius Scale (°C)	Fahrenheit Scale (°F)
	150	300
First frying of potatoes	170	340
	175	350
	180	360
Second frying of potatoes	190	375
Frying chicken and fish	195	380
	200	390

PRESERVING

1. **DO NOT** use a pan that overlaps the perimeter of the hob trim.

2. To allow for a full rolling boil, the pan should be no more than one third full when all the ingredients have been added. It is better to use two pans rather than overfill one, or use half quantities.

3. Use firm fruit or vegetables and wash well before using.

4. Preserving sugar gives clear jam, however granulated sugar is cheaper and gives equally good flavour.

5. Crystallization may be caused if sugar is not completely dissolved before bringing jam to the boil. Over boiling will affect the flavour, setting properties and colour of the jam.

6. To test jam for setting:

If a jam thermometer is available, boil jam to 104°C. Marmalade should be boiled to 106°C.

If a jam thermometer is not available, remove pan from heat, place sample of jam on a cold dish, and cool quickly (i.e. in a freezer or frozen food storage compartment of a refrigerator). When cold, it will crinkle and hold the mark of a finger run through it, if it is at setting point.

7. The scum should be removed as soon as possible after setting point has been reached. Marmalade should be allowed to cool before potting to prevent the peel rising.

THE DUAL GRILL

USES OF THE DUAL GRILL

CAUTION - ACCESSIBLE PARTS MAY BECOME HOT WHEN THE GRILL IS IN USE. CHILDREN SHOULD BE KEPT AWAY.

The Dual Grill on this appliance has been designed to heat up more quickly than conventional grill elements. It provides quick, direct heat and no preheating is necessary. It has a dual circuit facility which means that the full area of the grill can be used, or for economy purposes the centre section only can be used when cooking smaller quantities of food.

SELECTING THE GRILL

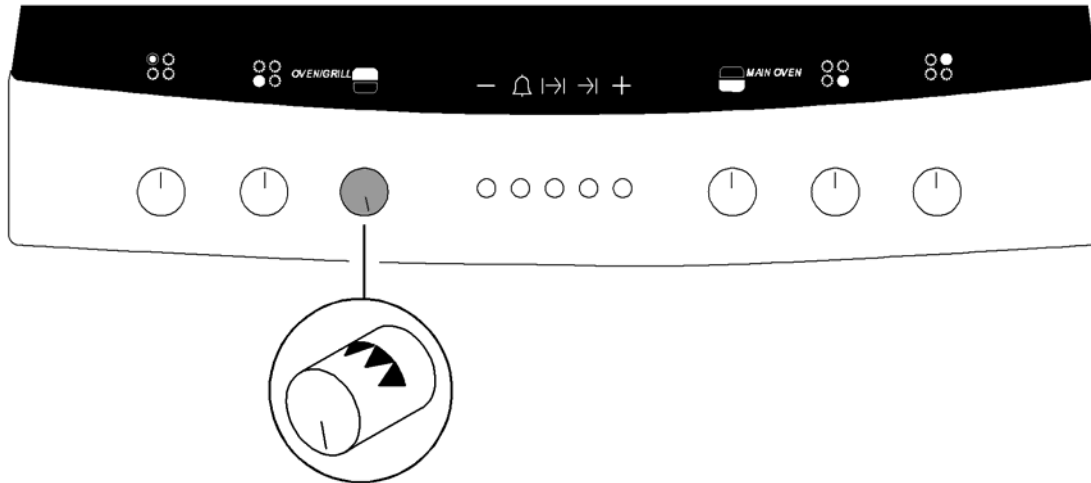

- To operate the grill turn the top oven/grill control clockwise to the full power setting (▼▼▼), then turn down as necessary.

The grill settings are as follows:-

- (▼) Full grill area at ¼ power.
- (▼▼) Centre grill area at full power.
- (▼▼▼) Full grill area at full power.

THINGS TO NOTE

THE GRILL DOOR MUST BE LEFT OPEN DURING GRILLING.

THE COOLING FAN WILL OPERATE IN CONJUNCTION WITH THE GRILL.

DO NOT LEAVE APPLIANCE UNATTENDED WHEN GRILL IS IN USE.

ALWAYS USE THE GRILL CONTROL TO TURN OFF THE GRILL

The top oven cannot be operated when the grill is in use.

Some smoke from fat splashes may be evident as the grill cleans itself.

THE GRILL PAN AND HANDLE

The grill pan is supplied with a removable handle.

To attach the handle, place the wirework under the cut out in the pan so that the metal plate hooks over the top of the grill pan.

Slide the handle to the left and over the central bump on the grill pan.

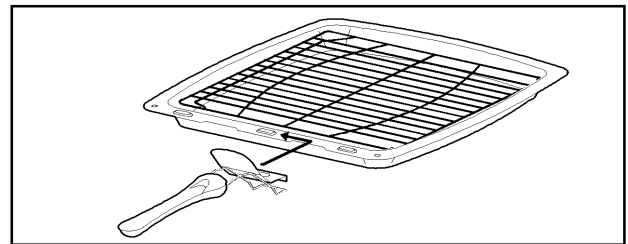

Ensure the handle is correctly located. It is not necessary to remove the grill pan handle during grilling.

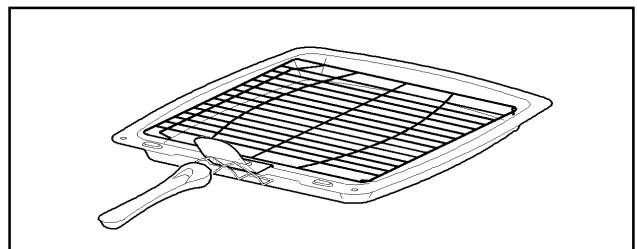

To remove the handle, slide the handle to the right and lift the handle away from the cut out on the grill pan.

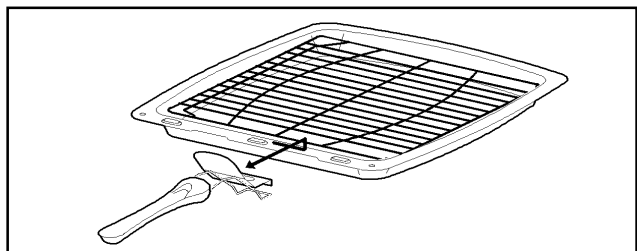

Place the grill pan on the shelf so that the pan is positioned centrally beneath the grill.

To check the progress of the food being grilled, the grill pan should be withdrawn on the shelf to attend to food during cooking.

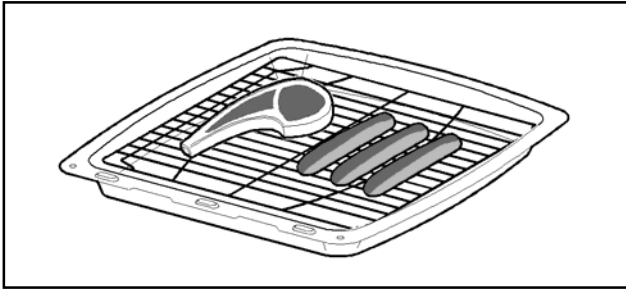

HINTS AND TIPS

- In order to become acquainted with the performance of the Dual Grill it is advisable to check food regularly when grilling.
- Food should be thoroughly dried before grilling to minimise splashing. Brush lean meats and fish lightly with a little oil or melted butter to keep them moist during cooking.

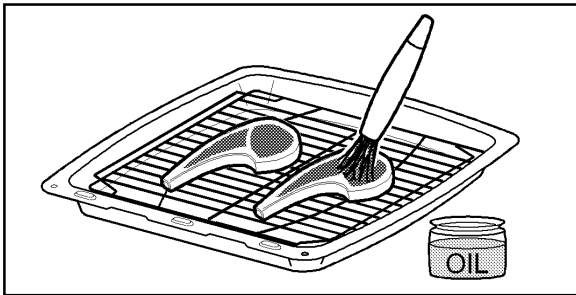

- Adjust the grid and grill pan runner position to allow for different thicknesses of foods.
- Accompaniments such as tomatoes and mushrooms may be placed underneath the grid when grilling meats.

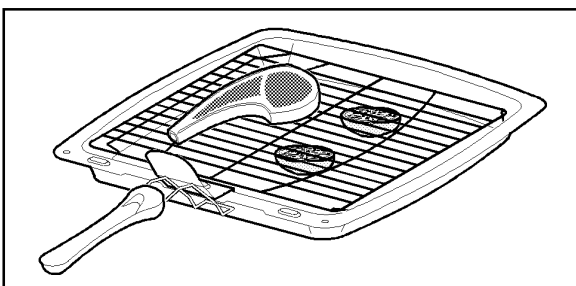

- When toasting bread, use the shelf in position 1 with the grid in the 'high' position.
- Preheat the grill on a full setting for a few minutes before sealing steaks or toasting. Adjust the heat setting and the shelf as necessary during cooking.
- The food should be turned over during cooking as required.
- When using the centre section of the dual grill, ensure food is positioned centrally on the grill pan grid in the grill pan.

NOTE

If you require an additional handle for your grill pan, this can be ordered from your local Service Force Centre by quoting part number 311479800\6.

GRILLING CHART

FOOD	SHELF	GRILL TIME (mins in total)
Bacon Rashers	Adjust	5 - 6
Beefburgers	grill setting	10 - 15
Chicken Joints	shelf	30 - 40
Chops – Lamb Pork	position and	15 - 20 20 - 30
Fish – Whole Trout/Mackerel	grill	15 - 25
Fillets – Plaice/Cod	pan	10 - 15
Kebabs	grid	20 - 30
Kidneys – Lamb/Pig	to	8 - 12
Liver – Lamb/Pig	suit	10 - 20
Sausages	different	20 - 30
Steaks – Rare Medium Well Done	thicknesses of	6 - 12 12 - 16 14 - 20
Toasted Sandwiches	food	3 - 4

Shelf positions are counted from the bottom upwards.

The times quoted above are given as a guide and should be adjusted to suit personal taste.

THE TOP OVEN

USES OF THE TOP OVEN

The top oven is the smaller of the two ovens. It is heated by elements in the top and bottom of the oven. It is designed for cooking smaller quantities of food. It gives especially good results if used to cook fruit cakes, sweets and savoury flans or quiche.

The top oven is also ideal for use as warming compartment to warm dishes and keep food hot. Use the lowest setting on the top oven temperature control.

SELECTING THE TOP OVEN

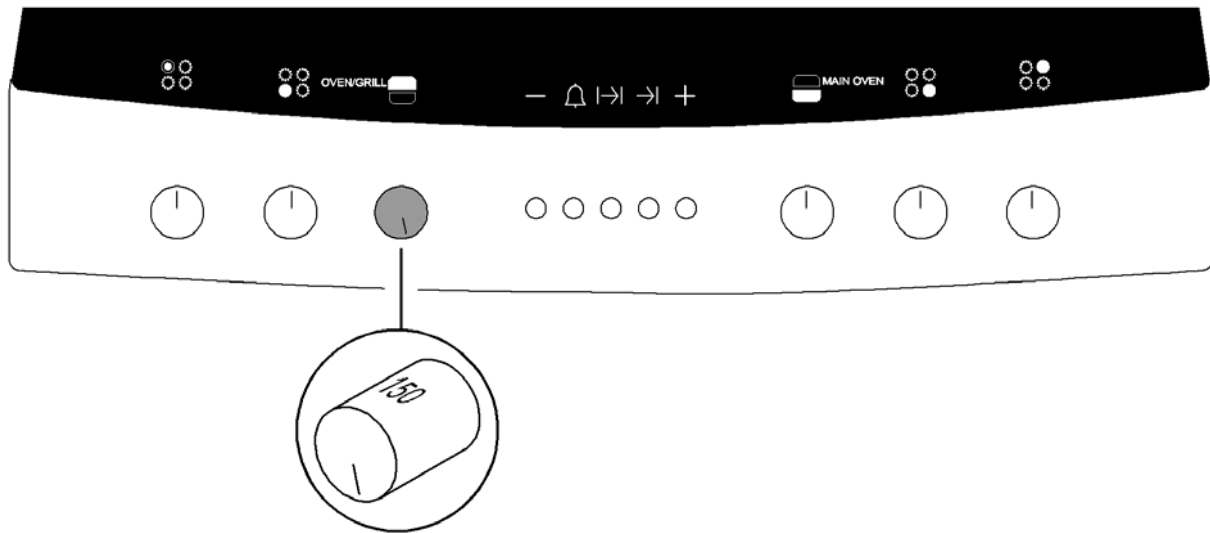

- Turn the top oven temperature control to the required setting. Our diagram shows the oven set to 150°C. Close the oven door.

THINGS TO NOTE

1. The grill cannot be operated when the top oven is in use. Only the outer part of the top oven element in conjunction with the base element will operate when using the top oven.
2. The indicator neon will glow. It may turn ON and OFF during use to show that the setting is being maintained.
3. Always place plates on the oven shelf to warm. Never place dishes directly on the top oven base as it becomes very hot and damage may occur.

TO FIT THE TOP OVEN SHELF

The shelf should be fitted with the straight rods uppermost on the frame and the forms towards the back of the oven. If not fitted correctly the anti-tilt and safety stop mechanism will be affected.

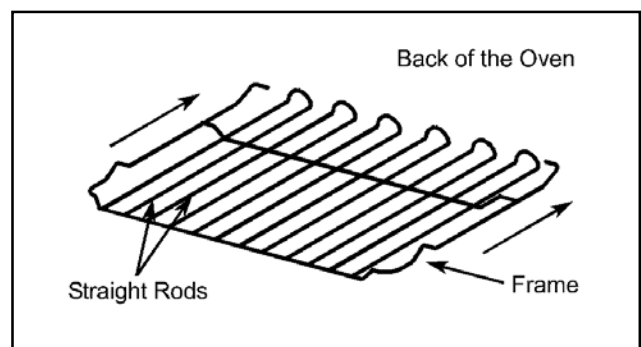

HINTS AND TIPS

- All cooking should be carried out using an oven shelf positioned in one of the shelf runners.

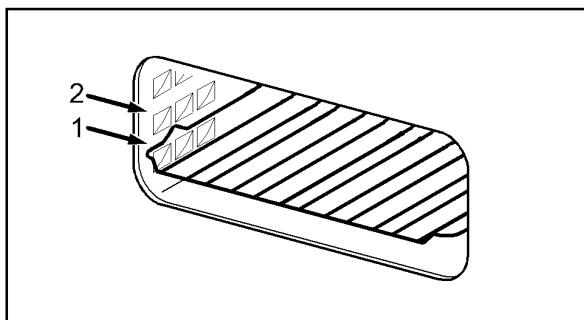

- Larger roasts and casseroles should normally be cooked in the main oven. However, they may be cooked on a flat shelf from the main oven placed on the base of the top oven provided there is sufficient room for air circulation around the food.
- Stand dishes on a suitably sized baking tray on the shelf to prevent spillage onto the oven base and to help reduce cleaning.

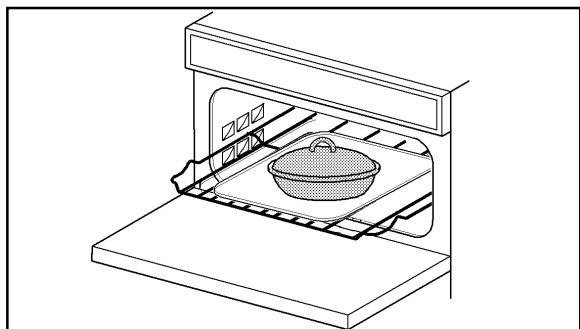

- There should always be at least 2.5cm (1") between the top of the food and the element. This gives best cooking results and allows room for rise in yeast mixtures, Yorkshire puddings etc.

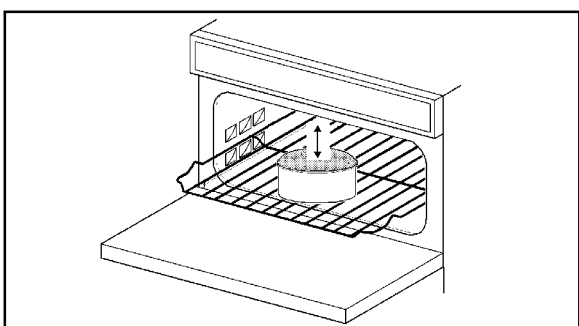

- When cooking cakes, pastry, scones, bread etc., place the tins or baking trays centrally on the shelf directly below the element.

- **DO NOT** place dishes or baking trays directly onto the oven base as it becomes very hot and damage may occur.

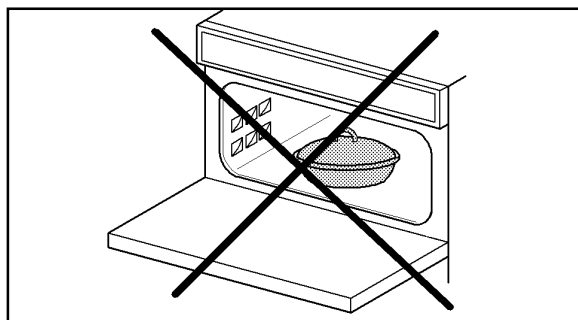

- The material and finish of the baking trays and dishes will affect the degree of base browning of the food. Enamelware, dark, heavy or non-stick utensils increase base browning. Shiny aluminium or polished steel trays reflect the heat away and give less base browning.
- **DO NOT** use the grill pan as a baking tray as this will increase base browning of the food.
- Because of the smaller cooking space, lower temperatures and shorter cooking times are sometimes required.
- For economy leave the door open for the shortest possible time, particularly when placing food into a pre-heated oven.

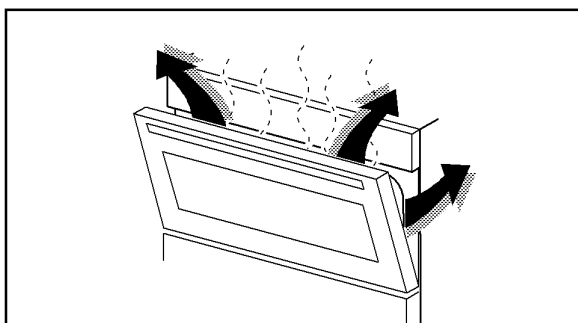

THE MAIN FAN OVEN

USES OF THE FAN OVEN

PREHEATING

The fan oven quickly reaches its temperature, so it is not usually necessary to preheat the oven. Without preheating however, you may find you need to add an extra 5-10 minutes on the recommended cooking times. For recipes needing high temperatures, e.g. bread, pastries, scones, soufflés etc., best results are achieved if the oven is preheated first. For best results when cooking frozen or cooked chilled ready meals always preheat the oven first.

COOKING TEMPERATURES

Fan oven cooking generally requires lower temperatures than conventional cooking. Follow the temperatures recommended in the oven cooking chart. As a guide reduce temperatures by about 20°C - 25°C for your own recipes, using a conventional oven.

BATCH BAKING

The fan oven cooks evenly on all shelf levels, especially useful when batch baking.

SELECTING THE MAIN OVEN

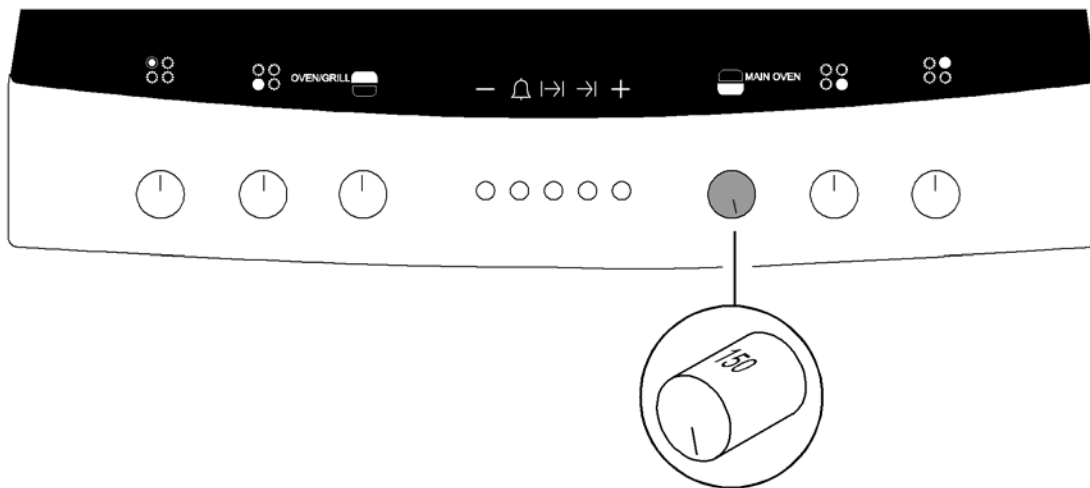

- Turn the main oven temperature control to the required setting.

THINGS TO NOTE

1. The indicator neon will glow. It may turn ON and OFF during use to show that the setting is being maintained.
2. The cooling fan for the controls may switch in after a time.

TO FIT THE MAIN OVEN SHELVES

The shelves should be fitted with the straight rods uppermost on the frame and the forms towards the back of the oven. If not fitted correctly the anti-tilt and safety stop mechanism will be affected.

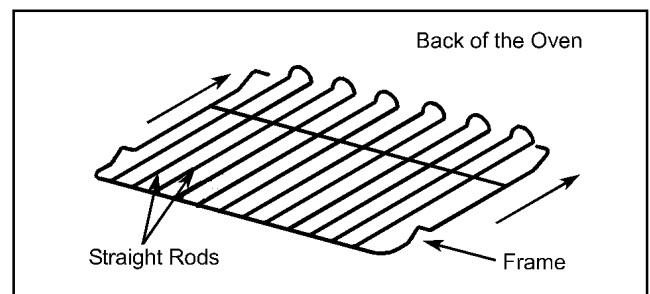

HINTS AND TIPS

- Arrange the shelves in the required positions before switching the oven ON. Shelf positions are numbered from the bottom upwards.

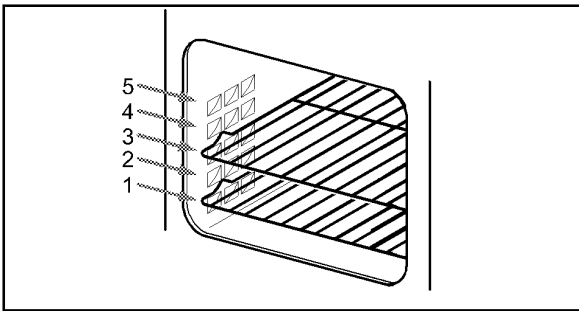

- When cooking more than one dish in the fan oven, place dishes centrally on different shelves rather than cluster several dishes on one shelf, this will allow the heat to circulate freely for the best cooking results.
- When batch baking one type of food, e.g. Victoria sandwich cakes, those of similar size will be cooked in the same time.

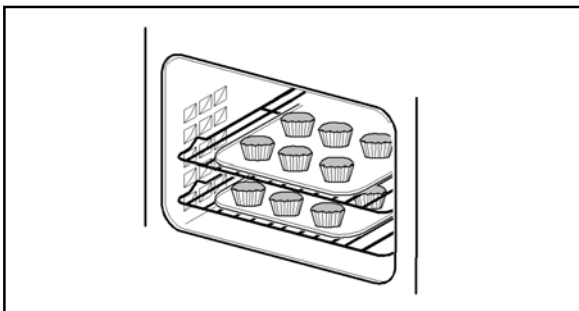

- It is recommended that when baking larger quantities, the shelf positions should be evenly spaced to suit the load being cooked. A slight increase in cooking time may be necessary.
- **DO NOT** place baking trays directly on the oven base as it interferes with the oven air circulation and can lead to base burning; use the lower shelf position.

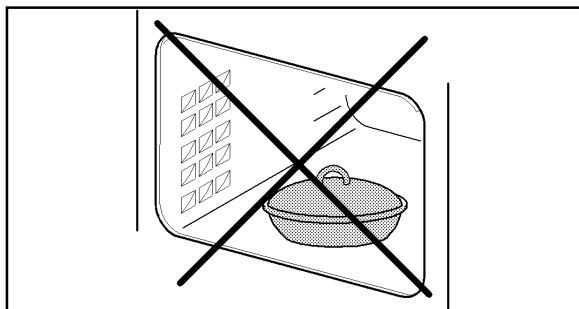

- The use of excessively high temperatures can cause uneven browning. It may be necessary to reduce temperatures slightly. Refer to the recommendations given in the oven cooking chart.

OVEN COOKING CHART

The oven temperatures are intended as a guide only. It may be necessary to increase or decrease the temperatures by 10°C to suit individual preferences and requirements.

FOOD	FAN OVEN		TOP OVEN		
	SHELF POSITION	COOKING TEMP °C	SHELF POSITION	COOKING TEMP°C	APPROX COOK TIME (m)
Biscuits		180 - 190	1	170 - 190	10 - 20
Bread		200 - 220	1*	200 - 220	25 - 30
Bread rolls/buns	Shelf	200 - 220	1	200 - 220	15 - 20
Cakes:	Small & Queen	160 - 170	1	180 - 190	18 - 25
	Sponges	160 - 170	1	160 - 170	18 - 20
	Victoria Sandwich	160 - 170	1	160 - 170	18 - 25
	Madeira	140 - 150	1	140 - 150	1¼ - 1½h
	Rich Fruit	130 - 140	1	140 - 150	2¼ - 2½h
	Christmas	130 - 140	1	130 - 140	3 - 4½h
	Gingerbread	140 - 150	1	140 - 150	depends on size 1¼ - 1½h
	Meringues	80 - 100	1	90 - 100	2½ - 3h
	Flapjack	170 - 180	1	170 - 180	25 - 30
	Shortbread	130 - 140	1	140 - 150	45 - 65
Casseroles:	Beef/Lamb	140 - 160	1*	140 - 160	2½ - 3h
	Chicken	180 - 190	1*	180 - 190	1¼ - 1½h
Convenience Foods		Follow manufacturer's instructions			
Fish	that oven	170 - 190	1	170 - 190	20 - 30
Fish Pie (Potato Topped)		190 - 200	1*	190 - 200	20 - 25
Fruit Pies, Crumbles		190 - 200	1	190 - 200	40 - 50
Milk Puddings	shelves are	130 - 140	1	140 - 150	1½ - 2h
Pasta Lasagne etc.		190 - 200	1	170 - 180	40 - 45
Pastry:	Choux	190 - 200	1	180 - 190	30 - 35
	Eclairs, Profiteroles	170 - 180	1	170 - 180	20 - 30
	Flaky/Puff Pies	210 - 220	1*	210 - 220	25 - 40
Shortcrust	Mince Pies	190 - 200	1	190 - 200	15 - 20
	Meat Pies	190 - 210	1*	190 - 210	25 - 35
	Quiche, Tarts, Flans	180 - 210	1	180 - 200	25 - 45
Roasting Meat, Poultry		160 - 180	1*	160 - 180	see roasting chart
Scones	when more	210 - 220	1	220 - 230	8 - 12
Shepherd's Pie		190 - 200	1*	190 - 200	30 - 40
Soufflés		170 - 180	1	170 - 180	20 - 30
Vegetables:	Baked Jacket Potatoes	180 - 190	1	180 - 190	1 - 1½h
	Roast Potatoes	180 - 190	1	180 - 190	1 - 1½h
Yorkshire Puddings:	Large	210 - 220	1	200 - 210	25 - 40
	Individual	200 - 210	1	200 - 210	15 - 25

* on a straight shelf on the oven base.

Note: Shelf positions are counted from the bottom of the oven.

ROASTING CHART

ROASTING CHART		
INTERNAL TEMPERATURES – Rare : 50-60°C; Medium : 60-70°C; Well done : 70-80°C		
MEAT	SECOND/ FAN OVEN	COOKING TIME
Beef	160-180°C	20-35 minutes per ½kg (1lb) and 20-35 minutes over
Beef, boned	160-180°C	25-35 minutes per ½kg (1lb) and 25-35 minutes over
Mutton and Lamb	160-180°C	25-35 minutes per ½kg (1lb) and 25-35 minutes over
Pork and Veal	160-180°C	30-40 minutes per ½kg (1lb) and 30-40 minutes over
Ham	160-180°C	30-40 minutes per ½kg (1lb) and 30-40 minutes over
Chicken	160-180°C	15-20 minutes per ½kg (1lb) and 20 minutes over
Turkey and Goose	160-180°C	15-20 minutes per ½kg (1lb) up to 3½kg (7lb) then 10 minutes per ½kg (1lb) over 3½kg (7lb)
Duck	160-180°C	25-35 minutes per ½kg (1lb) and 25-30 minutes over
Pheasant	160-180°C	35-40 minutes per ½kg (1lb) and 35-40 minutes over
Rabbit	160-180°C	20 minutes per ½kg (1lb) and 20 minutes over
Potatoes with meat	160-180°C	according to size
Potatoes without meat	180-190°C	according to size

The roasting temperatures and times given in the chart should be adequate for most joints, but slight adjustments may be required to allow for personal requirements and the shape and texture of the meat. However, lower temperatures and longer cooking times are recommended for less tender cuts or larger joints.

Wrap joints in foil if preferred, for extra browning uncover for the last 20 – 30 min. cooking time.

DEFROST FEATURE

USES OF DEFROST FEATURE

This fan oven function defrosts most foods faster than more conventional methods. It is particularly suitable for delicate frozen foods which are to be served cold, e.g. cream filled gateaux, cakes covered with icings or frostings, cheesecakes, biscuits, scones, etc.

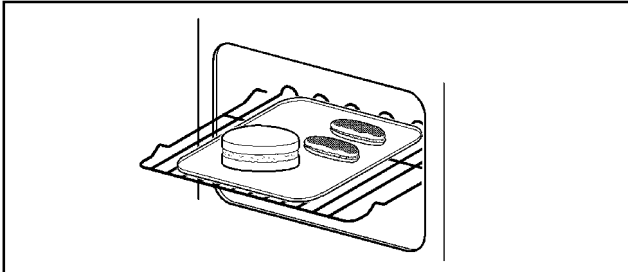

It is preferable to thaw fish, meat and poultry slowly in the fridge. However, this process can be accelerated by using the defrost function.

SELECTING DEFROST

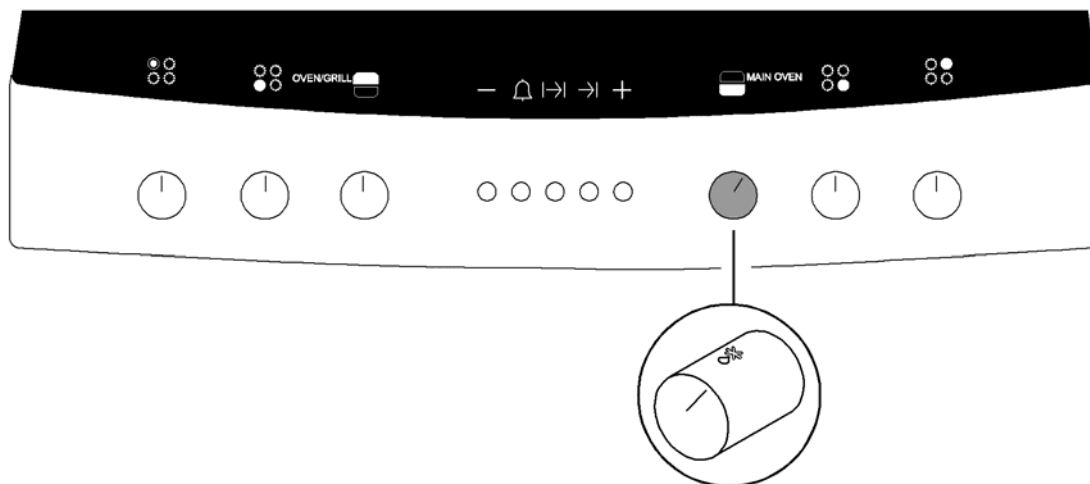

- Turn the main oven temperature control to the defrost setting. ❌
- When defrost is selected, the oven indicator neon may come ON. It will stay ON until the oven reaches room temperature and then go OFF.
- It may turn ON and OFF periodically during defrosting to maintain a steady room temperature, inside the oven.

THINGS TO NOTE

Care must always be taken when handling foods in the home. Always follow the basic rules of food hygiene to prevent bacterial growth and cross contamination when defrosting, preparing, cooking, cooling and freezing foods.

Small or thin fish fillets, frozen peeled prawns, cubed or minced meat, liver, thin chops, steaks etc., can be thawed in 1 – 2 hours.

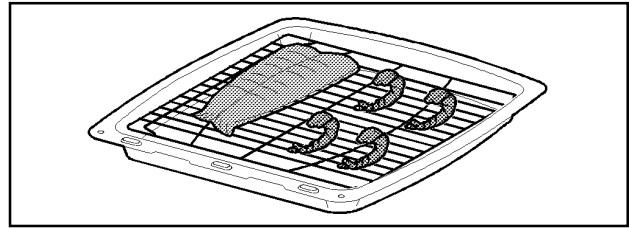

A 1kg/2¼lb oven ready chicken will be thawed in approximately 5 hours. Remove the giblets as soon as possible during the thawing process.

Joints of meat up to 2kg/4½lb in weight can be thawed using the defrost function.

ALL JOINTS OF MEAT AND POULTRY MUST BE THAWED THOROUGHLY BEFORE COOKING

ALWAYS COOK THOROUGHLY IMMEDIATELY AFTER THAWING.

HINTS AND TIPS

- Place the frozen food in a single layer where possible and turn it over half way through the defrosting process.

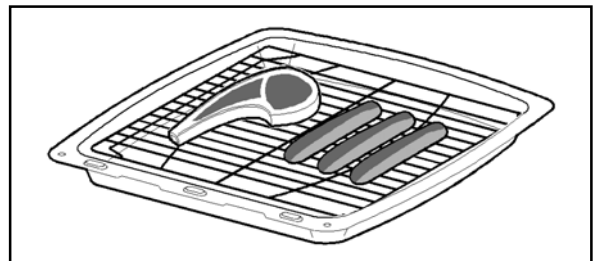

- The actual speed of defrosting is influenced by room temperature. On warm days defrosting will be faster than on cooler days.
- **DO NOT** leave food at room temperature once it is defrosted. Cook raw food immediately or store cooked food in the fridge, once it has cooled.

CARE AND CLEANING

BEFORE CLEANING THE APPLIANCE, ALWAYS ALLOW THE COOLING FAN TO COOL THE APPLIANCE DOWN BEFORE SWITCHING OFF THE ELECTRICITY SUPPLY.

CLEANING MATERIALS

Before using any cleaning materials on your appliance, check that they are suitable and that their use is recommended by the manufacturer.

Cleaners that contain bleach should NOT be used as they may dull the surface finishes. Harsh abrasives must also be avoided to prevent damaging the stainless steel or painted finishes. Multi-surface anti-bacterial products should not be used on the ceramic hob or on the surrounding trims.

CLEANING THE BRASS PLATED HANDLES (Where applicable)

It is strongly recommended that only soapy water is used for cleaning the handles. ANY OTHER CLEANING MATERIALS WILL DULL THE BRASS PLATED FINISH.

CLEANING THE CERAMIC HOB

Make sure the ceramic glass is cool before cleaning. It is important to clean the ceramic hob daily to prevent soilage being burnt on.

Take care to avoid the hob trims when cleaning the ceramic glass as they may be damaged by the cleaning agents recommended.

DAILY CLEANING

Use the recommended Hob Brite Cleaner daily. If soilage is not allowed to burn on it will be much easier to clean off.

1. Apply a small amount of Hob Brite in the centre of each area to be cleaned.

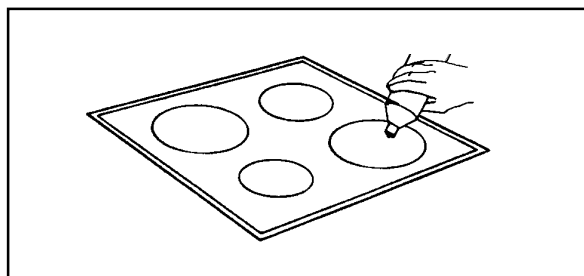

2. Dampen a clean paper towel or a plastic pad made specially for non-stick saucepans and rub vigorously until all marks are removed. This may take a few minutes.

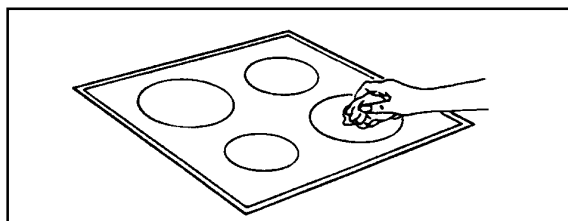

3. Wipe off residues of cleaner with another damp paper towel and polish dry with a soft cloth.

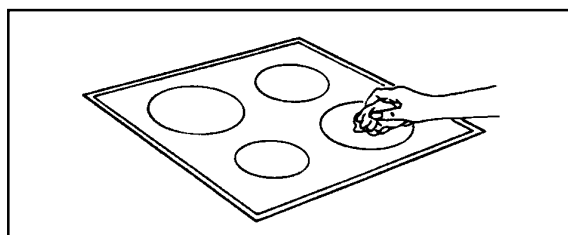

If Hob Brite is unavailable, one or more of the cleaning agents below may be used temporarily:

- a) Cif Cream Cleaner
- b) Baking Soda

TO REMOVE MORE STUBBORN MARKS

1. Bar-Keepers Friend may be used to clean off more stubborn stains or to remove discolourations. It may be necessary to rub the marks hard for several minutes.
2. Use a plastic pad specially for non-stick saucepans with Bar-Keepers Friend for removal of more stubborn soilage.

TO REMOVE BURNT ON SOILAGE

We strongly recommend the use of a Ceramic Hob Scraper (incorporating a single edge razor blade) to remove spillage on the hob, in particular sugar solutions, which if not removed can cause permanent damage.

1. Make sure the ceramic glass is cool.
2. Use a ceramic hob scraper with care at an angle of 30° to remove as much soilage as possible.

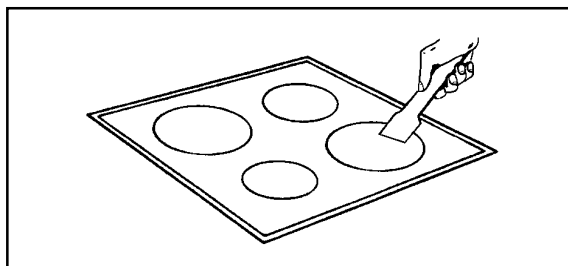

3. Use Bar-Keepers Friend or Hob Brite to finish off as directed above.

TO REMOVE DISCOLOURATIONS OR WHITE AND SILVER MARKS

These marks sometimes give the impression of being in or underneath the hob glass. They can almost always be removed provided they have not become excessively burnt on. Follow the instructions above under 'To Remove More Stubborn Marks'.

If this is unsuccessful, make up a paste of one part water to three parts Cream of Tarter and leave on the discoloured areas overnight. The marks should be easily removable the next day provided they have not been excessively burnt on. The paste should be thoroughly washed off afterwards.

HINTS AND TIPS

TO REDUCE HOB SOILAGE:

- Make sure the bottom of the saucepan and the cooking area are clean and dry before cooking begins.
- Ensure saucepans are large enough to accommodate food to avoid boil overs.
- If possible, wipe up spills and splatters as they occur, but take care to avoid steam burns.
- Avoid using a dishcloth or sponge to clean the hob. These may leave a layer of soiled detergent on the hob surface which will burn and discolour the next time the hob is used.
- Avoid the use of:
 - Household detergents and bleaches. Impregnated plastic or nylon pads that are not described as suitable for non-stick saucepans.
 - Brillo pads, Ajax pads, steel wool pads.
 - Chemical oven cleaners, e.g. aerosols and oven pads.
 - Rust stain, bath and sink stain removers.
 - **Any of the above products may cause damage to the hob.**
- It is dangerous to mix different cleaning products. The chemicals in them may react with each other with hazardous results.
- **SOILAGE FROM SUGAR SOLUTIONS MUST BE REMOVED FROM THE HOB BEFORE THE SYRUP HAS SET OTHERWISE DAMAGE TO THE HOB SURFACE WILL OCCUR.**
- Avoid placing plastic items, aluminium foil or dishes on the hot surface as this will cause damage to the hob.

CLEANING THE OUTSIDE OF THE APPLIANCE

DO NOT use abrasive cleaning materials e.g. Hob Brite, Brillo pads or scourers on painted or printed finishes as damage may occur. Regularly wipe over the control panel, oven doors and cooker sides using a soft cloth and hot soapy water. To prevent streaking on stainless steel models finish with a soft cloth.

Any spillage on the stainless steel finish must be wiped off immediately.

Stainless Steel cream cleaners are abrasive and should be avoided as they may dull the surface finish.

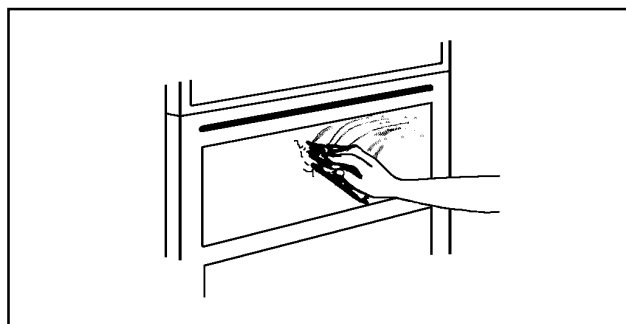

DO NOT ATTEMPT TO REMOVE ANY OF THE CONTROL KNOBS FROM THE PANEL AS THIS MAY CAUSE DAMAGE AND IS A SAFETY HAZARD.

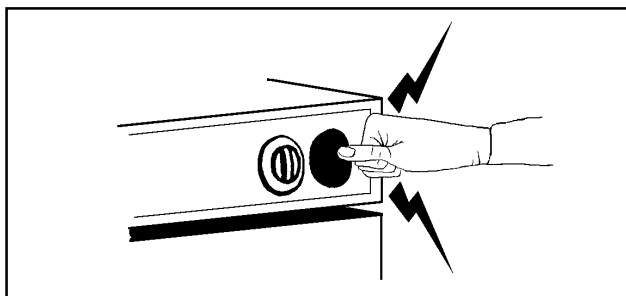

CLEANING THE GRILL AND OVEN FURNITURE

All removable parts, except the grill pan handle can be washed in the dishwasher.

The grill pan, grill pan grid and oven shelves may be cleaned using a soap impregnated steel wool pad. Soaking first in hot soapy water will make cleaning easier.

CLEANING INSIDE THE OVEN AND GRILL COMPARTMENTS

The sides and back panel of the top oven/grill and main oven compartments are coated with a Stayclean Coating.

The Stayclean surfaces should not be cleaned manually. See 'Care of Stayclean Surfaces'.

The vitreous enamel main oven base, and top oven/grill compartment base can be cleaned using normal oven cleaners or aerosol oven cleaners with care. Ensure that the manufacturer's instructions are followed and that all parts are well rinsed afterwards.

Aerosol cleaners must not be used on the Stayclean surfaces and must not come into contact with elements as this may cause damage.

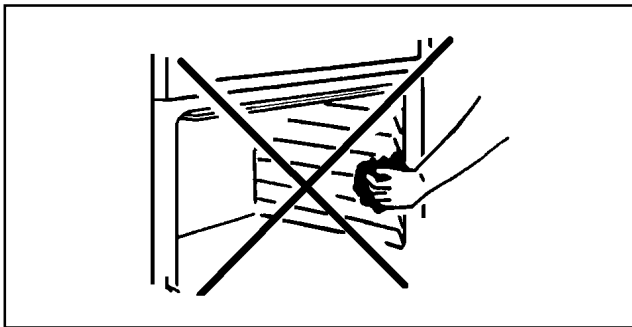

CARE OF STAYCLEAN SURFACES

Stayclean surfaces destroy splashes of food and fats when the oven temperature is raised to around 220°C.

It is a good idea to run the oven for an hour or two per week to ensure continued good performance from the Stayclean finish.

HINTS AND TIPS

- Manual cleaning of the Stayclean surface IS NOT recommended. Damage will occur if abrasives or aerosol sprays of any kind are used.
- Slight discolouration and polishing of the Stayclean surfaces may occur in time. This **DOES NOT** affect the Stayclean properties in any way.
- A good time to allow the oven to run on is after the weekly roast. After removing the roast, turn the oven up to 220°C and allow to run for an hour or so. It is important NOT to allow a build-up of soilage as this can prevent the Stayclean surfaces from working.
- Follow the recommendations to keep oven soilage to minimum.

- Cook at the recommended temperatures. Higher temperatures during roasting will increase soilage. Try cooking at lower temperatures for an increased length of time, you will save energy and often the joint is more tender.
- Use minimal, if any, extra oil or fat when roasting meat, potatoes only require brushing with fat before cooking. Extra fat in the oven during roasting will increase splashing and soilage.
- It is NOT necessary to add water to a meat tin when roasting. The water and the fat juices from the joint create excessive splattering during cooking – even at normal temperatures, as well as causing condensation.
- Covering joints during cooking will also prevent splashing onto the interior surfaces. Removing the covering for the last 20-30 minutes will allow extra browning if required. Some large joints and turkeys especially benefit by this method of cooking, allowing the joint to cook through before the outside is over-browned.

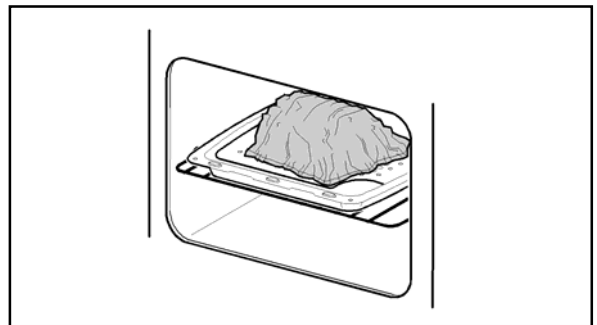

CLEANING THE DOOR GLASS



To prevent damaging or weakening the door glass panels avoid the use of the following:

- Household detergents and bleaches
- Impregnated pads unsuitable for non-stick saucepans
- Brillo/Ajax pads or steel wool pads
- Chemical oven pads or aerosols
- Rust removers
- Bath/Sink stain removers

CLEANING BETWEEN THE OUTER AND INNER DOOR GLASS

The outer door panel is removable for cleaning.

TO REMOVE THE OUTER GLASS

1. Open the oven door slightly to gain access to the two cross head screws on the top of the oven door.
2. Loosen the two screws using a Pozidrive screwdriver.

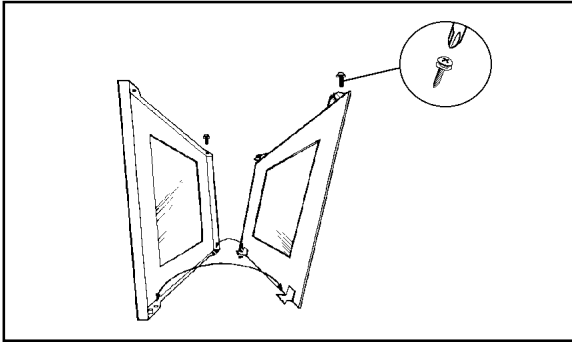

3. Hold the door glass securely in place with one hand before removing the screws completely with the other hand.
4. Using both hands, gently tilt the top of the door glass towards you, lift slightly to disengage the locators from the two bottom brackets.
5. Clean the outer and inner glass using hot soapy water or Hob Brite may be used with care. **DO NOT** use Hob Brite on the Stainless Steel or painted finishes. **DO NOT** try to clean the foil which is inside the door. The foil is there to help keep the door cool, if it is damaged it will not work. Ensure that all parts are well rinsed and thoroughly dried before attempting to replace the outer door.

TO REPLACE THE OUTER GLASS

1. Holding the door glass with both hands, gently place the locators into the holes of the brackets at the bottom of the oven door.
2. Push the top of the oven glass towards the oven door, ensuring the screw location holes line up.
3. Hold the panel in place with one hand and insert the cross head screws into the location holes with the other hand. Give the screws one turn to ensure the glass is secure.
4. Tighten the screws positively with a Pozidrive screwdriver before closing the oven door.

Do not attempt to use the oven without the glass being in place.

 If the door glass panel becomes chipped or has deep scratches the glass will be weakened and must be replaced to prevent the possibility of the panel shattering. Please contact your local Service Force Centre who will be pleased to advise further.

TO CLEAN THE INNER GLASS DOOR PANELS

Clean the inner glass door panels using a soft cloth and hot water to which a little washing up liquid has been added. If the inner panel is heavily soiled, Hob Brite may be used. **Do not** use abrasive cleaning materials on the door glass. Ensure that all parts are well rinsed and thoroughly dried before attempting to replace the glass.

REPLACING AN OVEN LIGHT BULB

The type of bulb required is a 300°C 25 watt small Edison Screw. Part number 572 491 5431-00/1 (Available through your local Service Force Centre).

CAUTION: DISCONNECT THE APPLIANCE FROM THE ELECTRICITY SUPPLY BEFORE REPLACING THE BULB.

Open the door and remove the shelves to enable easy access to the oven light assembly. Insert a flat blade screwdriver between the oven side and glass which covers the bulb.

Support the glass with your hand and prise out sufficiently to release the glass cover. Unscrew the bulb in an anticlockwise direction until it is possible to remove the bulb with ease.

Fit the new bulb by turning in a clockwise direction until it is secure. Ensuring the indent to the flange is pointing to the rear of the oven, replace the glass by pushing it firmly into the hole to cover the bulb assembly.

Replace the shelves. Restore the electricity supply and adjust the time of day and clock as necessary.

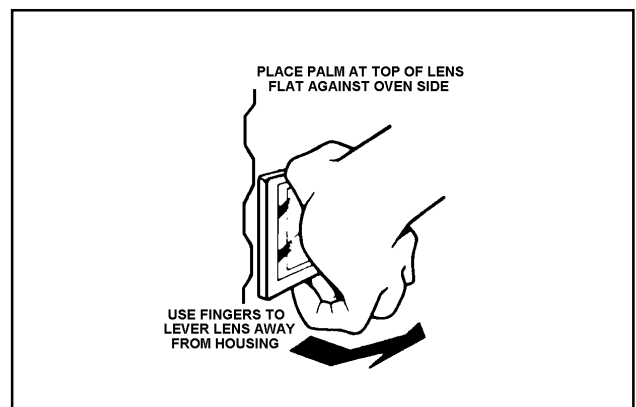

SOMETHING NOT WORKING?

We strongly recommend that you carry out the following checks on your appliance before calling a Service Engineer. It may be that the problem is a simple one which you can solve yourself without the expense of a service call.

If our Service Engineer finds that the problem is listed below you will be charged for the call whether or not the appliance is under guarantee.

The appliance does not work all:

- * Check that the appliance has been wired in and is switched on at the wall.
- * Check that the main appliance fuse is working.
- * Check that the timer is set to manual.

The oven temperature is too high or low:

- * Check that the recommended temperatures are being used. Be prepared to adjust the temperature up or down by 10°C to achieve the results you want.

The hotplates and main oven work but the grill does not:

- * Check that you have carefully followed the instructions for operation of the grill.
- * If the cooling fan fails the grill will not operate correctly. Please call your Local Service Force Centre.

If the oven is not cooking evenly or the side opening door will not stay open.

- * Check that the appliance is level.

The grill and hotplates work but the oven does not:

- * Check that the timer is set to manual operation.

The oven light fails to illuminate.

- * Check that the appliance is not set for automatic cooking. The light will illuminate when the cooktime begins.
- * If you have had your appliance for several months you may need to replace the light bulb.

The oven fan is noisy.

- * Check that the oven is level.
- * Check that bakeware and shelves are not vibrating in contact with the back panel in the oven.

SERVICE AND SPARE PARTS

In the event of your appliance requiring service, or if you wish to purchase spare parts, please contact your local Service Force Centre by telephoning:-

0870 5 929929

Your telephone call will be automatically routed to the Service Force Centre covering your post code area.

For the address of your local Service Force Centre and further information about Service Force, please visit the website at www.serviceforce.co.uk

Before calling out an engineer, please ensure you have read the details under the heading "Something Not Working".

When you contact the Service Force Centre you will need to give the following details:

1. Your name, address and post code.
2. Your telephone number.
3. Clear and concise details of the fault.
4. The model and serial number of the appliance (found on the rating plate).
5. The purchase date.

Please note that a valid purchase receipt or guarantee documentation is required for in-guarantee service calls.

For Customer Service in Ireland please contact us at the address below:

Zanussi-Electrolux
Electrolux Group (Irl) Ltd
Long Mile Road
Dublin 12
Republic of Ireland

Tel: +353 (0) 1 4090751

Email: service.eid@electrolux.ie

CUSTOMER CARE DEPARTMENT

For general enquires concerning your Zanussi-Electrolux appliance, or for further information on Zanussi-Electrolux products, please contact our Customer Care Department by letter or telephone at the address below or visit our website at www.zanussi-electrolux.co.uk

Customer Care Department
Zanussi-Electrolux
55 – 77 High Street
Slough
Berkshire
SL1 1DZ
Tel: 0870 5 727727 (*)

*calls to this number may be recorded for training purposes.

GUARANTEE CONDITIONS

Standard guarantee conditions

We, Zanussi-Electrolux, undertake that if within 12 months of the date of the purchase this ZANUSSI-ELECTROLUX appliance or any part thereof is proved to be defective by reason only of faulty workmanship or materials, we will, at our option repair or replace the same FREE OF CHARGE for labour, materials or carriage on condition that:

- The appliance has been correctly installed and used only on the electricity supply stated on the rating plate.
- The appliance has been used for normal domestic purposes only, and in accordance with the manufacturer's instructions.
- The appliance has not been serviced, maintained, repaired, taken apart or tampered with by any person not authorised by us.
- All service work under this guarantee must be undertaken by a Service Force Centre.
- Any appliance or defective part replaced shall become the Company's property.
- This guarantee is in addition to your statutory and other legal rights.

Home visits are made between **8.30am** and **5.30pm** Monday to Friday. Visits may be available outside these hours in which case a **premium** will be charged.

Exclusions

This guarantee does not cover:

- Damage or calls resulting from transportation, improper use or neglect, the replacement of any light bulbs or removable parts of glass or plastic.
- Costs incurred for calls to put right an appliance which is improperly installed or calls to appliances outside the United Kingdom.
- Appliances found to be in use within a commercial environment, plus those which are subject to rental agreements.
- Products of Zanussi-Electrolux manufacture which are not marketed by Zanussi-Electrolux.

European Guarantee

If you should move to another country within Europe then your guarantee moves with you to your new home subject to the following qualifications:

- The guarantee starts from the date you first purchased your product.
- The guarantee is for the same period and to the same extent for labour and parts as exists in the new country of use for this brand or range of products.
- This guarantee relates to you and cannot be transferred to another user.
- Your new home is within the European Community (EC) or European Free Trade Area.
- The product is installed and used in accordance with our instructions and is only used domestically, i.e. a normal household.
- The product is installed taking into account regulations in your new country.

Before you move please contact your nearest Customer Care centre, listed below, to give them details of your new home. They will then ensure that the local Service Organisation is aware of your move and able to look after you and your appliances.

France	Senlis	+33 (0) 3 44 62 29 29
Germany	Nürnberg	+49 (0) 800 234 7378
Italy	Pordernone	+39 (0) 0434 39 4700
Sweden	Stockholm	+46 (0) 8 672 53 90
UK	Slough	+44 (0) 1753 219897
Ireland	Dublin	+353 (0) 1 4090751

NOTES

NOTES

NOTES

IMPORTANT NOTICE

In line with our continuing policy of research and development, we reserve the right to alter models and specifications without prior notice.

This instruction booklet is accurate at the date of printing, but will be superseded if specifications or appearance are changed.

ZANUSSI-ELECTROLUX
55 – 77 HIGH STREET,
SLOUGH,
BERKSHIRE,
SL1 1DZ.
TELEPHONE 0870 5 727727
www.zanussi-electrolux.co.uk

Part Number: 311698300

© Electrolux plc 2003

 **From the Electrolux Group.** *The world's No.1 choice.*

The Electrolux Group is the world's largest producer of powered appliances for kitchen, cleaning and outdoor use. More than 55 million Electrolux Group products (such as refrigerators, cookers, washing machines, vacuum cleaners, chain saws and lawn mowers) are sold each year to a value of approx. USD 14 billion in more than 150 countries around the world.